

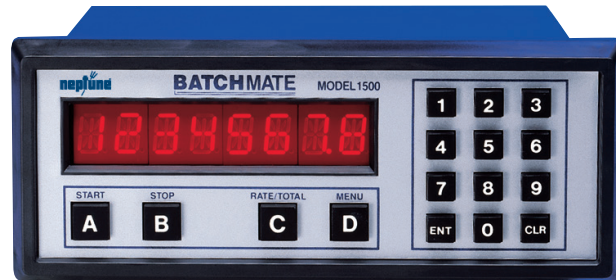

# BATCHMATE 1500™

## Batch Control Computer Technical Bulletin



### DESCRIPTION

The BATCHMATE features an 8 digit 0.55-in. alphanumeric LED display. The pulse input model will accept up to 20,000 pulses per second (pps) of digital count. The analog input version accepts a 4-20 mA input. This analog input is sent to a highly linear V to F converter to generate a 0-10 KHz pulse.

The Standard BATCHMATE has two separate, 8-digit floating decimal K-factors to convert the inputs to count and rate displays. An optional 16-point K-factor can linearize flow from meter outputs. The user, with the push of a button, can toggle back and forth to view the total of the batch, the rate of flow or the grand total of flow.

The BATCHMATE may be thought of as two separate counters and a rate meter. The "batching" counter counts to "pre-warn" and "preset" set points entered by the user and enabled separate control outputs. The "totalizing" counter gives a cumulative reading or grand total.

Additionally, the rate meter counts the number of pulses per second and, with its scaling feature, provides gpm or any other rate measurement. At any time, the user may view the total, the grand total or the rate, while never interrupting the counting process.

The front panel keypad controls the menu-driven software used for system set-up. Start/stop control can be activated via the front panel keys or remote switches.

The unit operates from either 110 VAC/12-27 VDC or from optional 220 VAC/12-27 VDC @ 100 mA power supplies

are offered. They can be connected to provide +12 VDC and -12 VDC or +24 VDC to drive external devices. CMOS logic is used to provide high noise immunity and low power consumption with EEPROM to hold data a minimum of 10 years if power is interrupted.

### FEATURES

- Preset counter with two stage batch control
- Displays total, rate or grand total
- Pulse or analog input
- K-factor programmable to 8 places
- NEMA 4X front panel
- Optional 4-20mA analog output
- Start/Stop buttons
- Scaled pulse output
- 20 KHz count speed
- Security lockout
- Remote Operation (start, stop, reset)
- Two-way RS232/422 communications
- Missing pulse (meter failure) detection
- Optional 16 point linearization

### APPLICATIONS

The BATCHMATE 1500 controls batching and totalizing of fluid flow. The programmable k-factor makes keying in engineering units easy. Start/Stop control in conjunction with pre-warn and preset relays provide 2 stage batching capability.

The BATCHMATE can be use with the Red Seal Type MP oscillating piston and Type S Nutating disk flowmeters for precise reliable batching.

# Specifications

<b>Display</b>	8-digit, 0.55 in. high, 15 segment, red-orange LED
<b>Input Power</b>	110 VAC $\pm$ 15% or 12-27 VDC 220 VAC $\pm$ 15% or 12-27 VDC
<b>Current</b>	Maximum 280 mA DC or 5.3 VA at rated AC voltage.
<b>Output Power</b>	(AC powered units only): 12 VDC at 100 mA. Separate isolated 12 VDC at 100 mA to allow $\pm$ 12 VDC or + 24 VDC regulated $\pm$ 5% worst case.
<b>Temperature</b>	Operating: 32° to 130°F (0° to 54°C) Storage: -40° to 200°F (-40° to 93°C)
<b>Memory</b>	EEPROM stores all display mode program and count data for a minimum of 10 years if power is lost.
<b>Pulse Inputs</b>	Option 00: standard, high impedance. Low: open or 0-1 VDC. High: 3-30 VDC. Impedance: 10K ohms. Max. speed: 20 KHz (min. on/off 25) See speed note under "Factored Output." Option 01: same as input 00, except has 10 K ohm pull-up resistor to +5 VDC for pulsing with contact closure to ground or NPN open collector transistor.
<b>Analog Inputs</b>	Current loop input is converted to a highly linear 0-10 KHz frequency. Can be scaled by the 8-digit K-factors to count or display rate in separate engineering units (see speed note under "Factored Output.") Options: 02/08: 4-20 mA, 250 ohm input impedance
<b>Input Accuracy</b>	Over full temperature range Analog: Zero error: $\pm$ 0.175% full scale maximum Overall error: $\pm$ 0.5% full scale maximum Digital: 100% (within specified voltage ranges)
<b>Reset</b>	Front push button: CLR resets the displayed counter and control output, if any. Remote: 3-30 VDC positive edge resets batch counter and control output. Impedance: 10K ohms to ground (-DC) Minimum Pulse: 5msec.

## Analog Output

Available on digital or analog input models, this output provides a 4-20 mA signal that corresponds to the rate reading. The user must key in the 4 and 20 mA settings at setup. A sinking driver generates a linear current through the external device. Accuracy is  $\pm$ 100mA. Compliance voltage must be 3-24 VDC, noninductive.

## Factored Pulse Output

BATCHMATE gives one pulse out for each factored count. Open collector sinks 30 VDC maximum to 1 V maximum at 100 mA maximum. Output speed is user selectable (see table). An internal buffer holds up to 10,000 pulses for output at the selected frequency before DATA LOST flashes, indicating pulses are lost. If factored rate exceeds 7 digits RFF flashes. These alarms indicate that speed has been exceeded.

## Control Outputs

SPDT relay. Contact ratings 10 A, 120/240 VAC or 28 VDC.

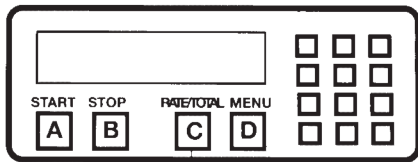

PRESS 'C' TO SEE RATE

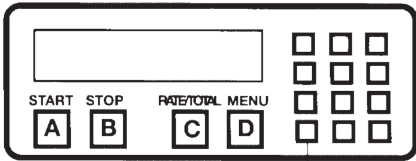

PRESS 'ENT' TO SEE GRANDTOTAL

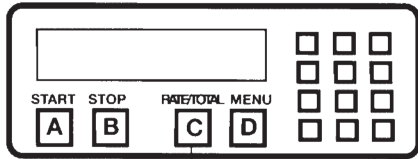

PRESS 'C' AGAIN TO SEE BATCHTOTAL

## PULSE TABLE

Speed, HZ	10	200	2,000	20,000
Min. on/off, msec	47.5	2.0	0.2	0.013

## OPERATIONS

### PRESETS

The user may enter two set points for the batch counter. The first preset determines the final batch size. The second setpoint, pre-warn, represents the number of displayed units before the final batch size (preset) setpoint.

### K-FACTOR

A programmable K-factor is used to convert the input pulses or frequency (generated internally by the analog input) to engineering units. The 8-digit K-factor is a divider with a range of 0.00011 to 99,999,999 (the decimal point may be keyed into any position). Separate k-factors are provided for the count and rate displays. Thus, batching and totalizing may be done in gallons and rate displayed in litres/hr. The maximum factored count speed is 20,000 Hz. The maximum factored rate is 7 digits.

The 16 point linearization variable K-factor option makes flow systems more accurate and often extends their usable range by allowing users to program different K-factors for different flow rates. It works with either pulse input or a standard analog current loop input.

From 3 to 16 frequency points can be assigned different K-factors from 0.00011 to 99,999,999. Settings should be programmed at set-up. The BATCHMATE uses 8-digit floating point match to interpolate K-factors between frequencies.

### MISSING PULSE (METER FAILURE) DETECTION

The user may enter a time from 0 to 99 seconds. If the time between pulses exceeds the period programmed, the BATCHMATE automatically shuts down and goes into a security lockout. To release the security lockout, the lock-out code must be entered. To override, a security time of 0 may be entered.

### COUNTER

The counter provides 8 digits of resolution with 2 levels of preset. In the setup mode, choose RO (reset to zero) to count up, or SP (set to preset) to count down. At any time, the display can be made to flash the grand total by pressing ENT while the unit is displaying the count in the run mode. Activating CLR while the grand total is flashing resets the grand total counter.

### RATE METER

The rate meter is accurate to 5 1/2 digits ( $\pm 1$  display digit). The rate meter can be programmed to accept almost any number of pulses per unit of measurement, sample from 2 to 24 seconds maximum and auto-range up to 6 digits of significant information.

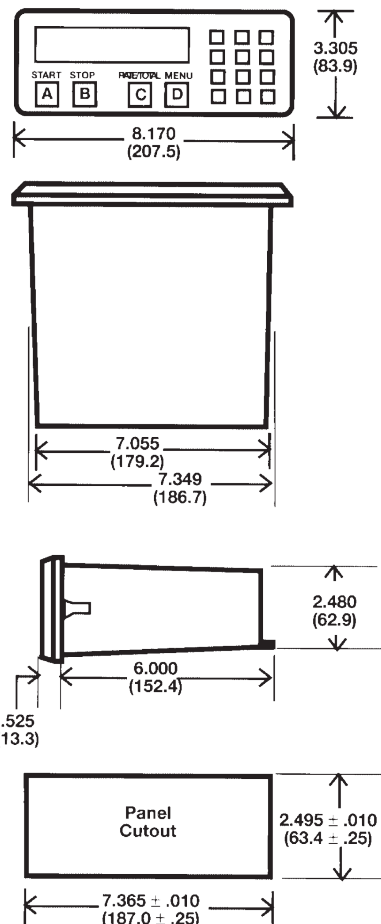

The rate meter with a K-factor of 1 displays the rate in pulses per second. Simply enter the proper K-factor to display in minutes, hours or other units of measurement. Press the C button while the unit is displaying the batch total to display the rate; R is displayed on the left side of the display.

### LOCK-OUT

A Security lock-out feature is available for preventing unauthorized front-panel parameter changes. Lock-out is activated by a user-selected, four digit code.

### OUTPUT CARD

RS232 or RS422 serial two-way communications are available. Up to 15 units can be linked together and addressed separately to transmit unit status or accept new set points in the standard ASCII format. They key-pad is used to select baud rates of 300, 600, 1200, 2400, 4800 or 9600 and parity of odd, even, space or mark.

- Option 1: RS232 serial interface
- Option 2: RS422 serial interface

### REMOTE OPERATION

The unit can be operated remotely via a 2 button system. The start button will start a remote batch. The stop button will stop the batch and, if pressed again, the stop button will reset the batch counter.

# ORDERING INFORMATION

## BATCHMATE 1500

Model Number BM15- _ _ _ _ - _ _ _ _		DESCRIPTION
	0 1	POWER SUPPLY 115 VAC 50/60 Hz or 12 to 27 VDC 230 VAC 50/60 Hz or 12 to 27 VDC
	0 0 <sup>1</sup> 0 0 <sup>2</sup>  0 2 0 8	CONTROL INPUTS (pulse/digital) STD High Impedance, Sourcing Transmitter, 3-30 VDC "On-State," 20 kHz Max. As above with 4.7 KΩ Pull-up Resistor, for Sinking Transmitter, (ex. PE 505, Dry Reed Switch Pulsers) CONTROL INPUTS (analog) (special order 4-Week Delivery) 4-20 mA DC 4-20 mA DC In, 4-20 mA DC Out (Input 08 does not support remote Start)
	1	OUTPUTS SPDT Relay, 10A
	1 2 3  4	INPUT SPEED 0-40 Hz 0-400 Hz 0-20 kHz Note: Options 1-3 are appropriate for control inputs 00 or 01 and may be changed in the field. Use for control inputs 02 and 08
	0 1  0 1 2  0 1	OPTIONS (All Can Be Selected) None 4-20 mA DC Output (for inputs 00 & 01) None RS 232 RS 422 None 16 Point Linearization (Option 001 does not support remote Start nor EZ PRE)
	1 2 3	MOUNTING CONFIGURATIONS <sup>2</sup> NEMA 4X Panel (Standard) NEMA 4X Wall Mount, 1 Unit NEMA 4X Wall Mount, 2 Units (additional unit must be ordered, see note 3)

1. Sourcing transmitter ex. 35 HR, 43 HR, 45 HR,
2. Sinking transmitter ex models 35, 43, 45
3. To mount 2 units in the same box order one with option 3 and one with option 1.

# TYPICAL BATCHMATE 1500™ APPLICATIONS

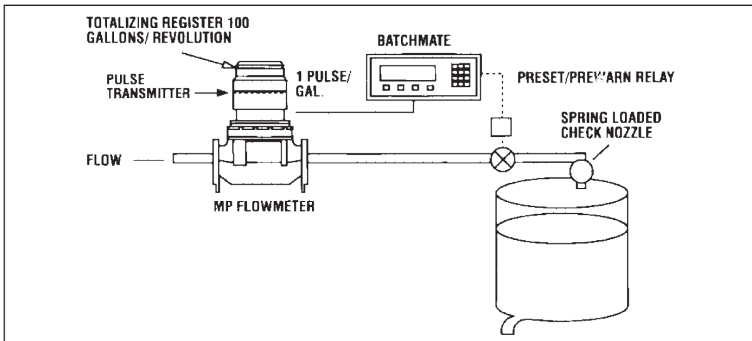

## ELECTRONIC BATCHING

Flow through the meter drives a pulse transmitter, connected to the BATCHMATE, enabling remote control of pumps, valves and mixers.

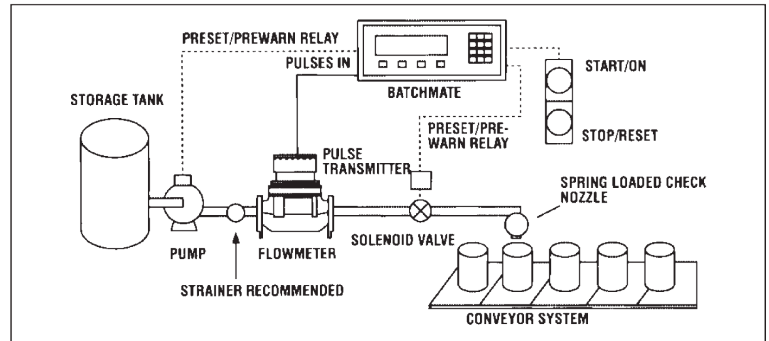

## REMOTE BATCHING

Filling system controlled by BATCHING via remote station.

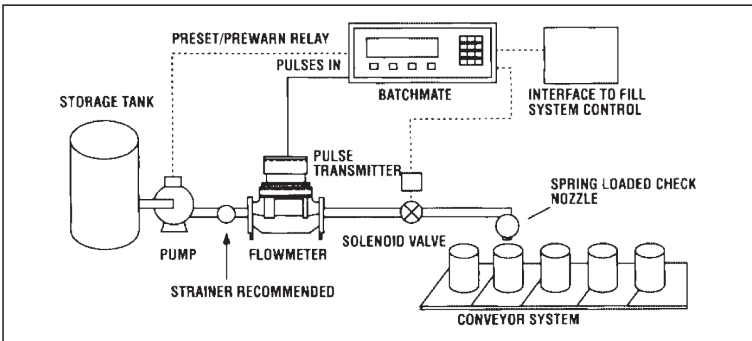

## AUTOMATIC REPEAT BATCHING

Filling system controlled by BATCHMATE via fill system controller.

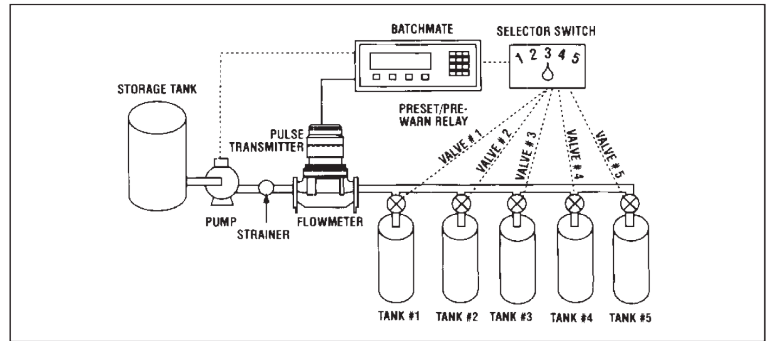

## BATCH TO MULTIPLE DESTINATIONS

The BATCHMATE is installed with the pump and a selector switch controlling valves to multiple tanks. A signal from the pulse transmitter enables a predetermined volume to be delivered to the designated tank.

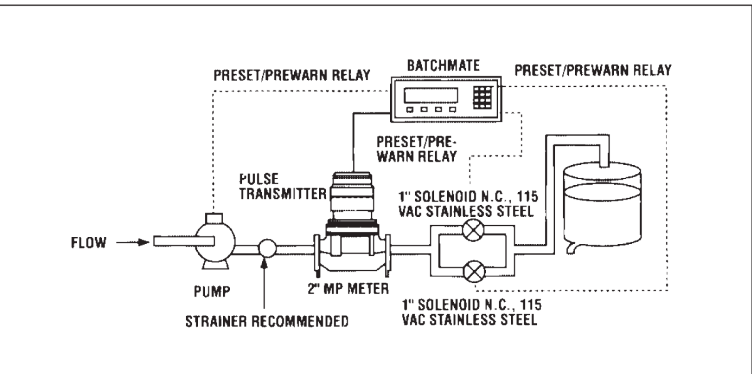

## TWO STAGE SHUT-OFF SYSTEM

Pre-signal and final shut-off output option of the BATCHMATE prevents hydraulic shock, even at high flow rates.

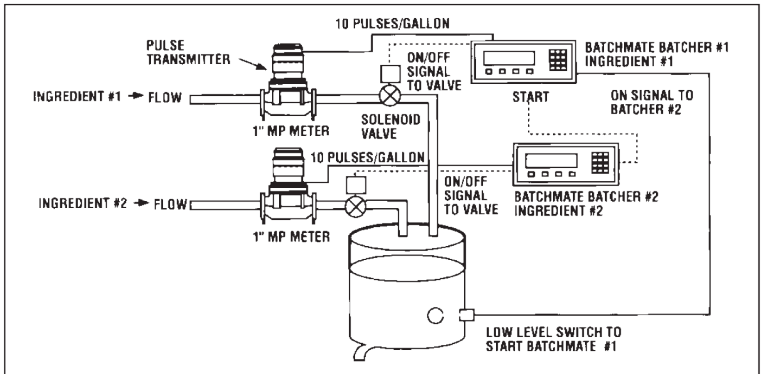

## DUAL INGREDIENT BATCHING

BATCHMATE No. 1 delivers preset quantity to tank. Upon reaching preset quantity, BATCHMATE No. 1 transmits signal to "start" switch of BATCHMATE No. 2, which delivers preset quantity to tank. Low level switch in tank energizes "start" switch on BATCHMATE No. 1, and sequence begins again.

1310 Emerald Road  
Greenwood, SC 29646  
USA  
Phone: 1.800.833.3357  
Fax: 1.864.223.0341

